

2/2-Wege Coaxialventil 2/2-way coaxial valve

Baureihe 280-X / 281-X / 282-X Type 280-X / 281-X / 282-X

fremdgesteuert
Modulbauweise

externally controlled
modular design

Schaltfunktion A: NC (stromlos geschlossen)
function A: NC (normally closed)

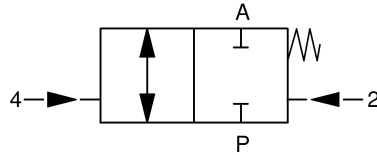

Schaltfunktion B: NO (stromlos offen)
function B: NO (normally open)

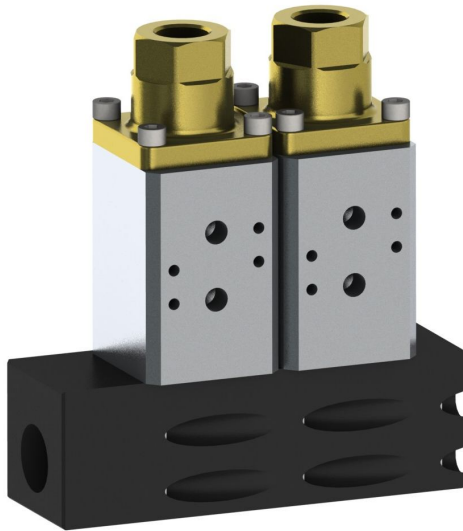
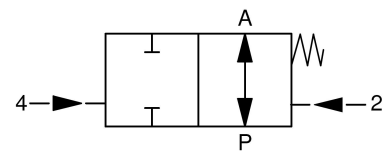

Nennweite	DN 10 – 50	diameter	DN 10 – 50
Druckbereich	0 – max. 160bar gegendrückt bis max. 16bar	pressure range	0 – max. 160bar backpressure leakproof up to max. 16bar
Gehäusewerkstoff	Einzelventil: Messing Block: Aluminium	body material	single valve: brass block: aluminium
Dichtwerkstoff	statisch: FKM dynamisch: FKM, PTFE Sitzdichtung: PTFE	seal material	static: FKM dynamic: FKM, PTFE seat seal: PTFE
Temperatur	Medium: -10 bis +100°C Umgebung: -10 bis +50°C	temperature	media: -10 up to +100°C ambient: -10 up to +50°C
Anschluss	Ventil: G1/4 – G2 Block: G1/2 – G2 1/2	connection	valve: G1/4 – G2 block: G1/2 – G2 1/2
Durchflußrichtung	P → A max. 160bar A → P max. 16bar	flow direction	P → A max. 160bar A → P max. 16bar
Antriebsteil	doppelt wirkender Kolben mit Rückstellfeder	actuating part	double acting piston with spring return
Steuerdruck	3 – 8bar Anschlüsse 2+4 (G1/4) Schnittstelle nach NAMUR	control pressure	3 – 8bar connections 2+4 (G1/4) port according to NAMUR
Schaltzeiten	eine vorgeschaltete Wartungseinheit verlängert die Lebensdauer der Ventile Öffnen / Schließen 50 – 1000ms Abhängig vom Steuerdruck, Pilotventil (Option) und Abluftdrosseln (Option)	switching time	an upstream service unit extends the lifetime of the valves opening / closing 50 – 1000ms depending on operating pressure, pilot valve (option) and exhaust air throttle (option)
Einbaulage	beliebig	mounting	in any position

2/2-Wege Coaxialventil
2/2-way coaxial valve
Baureihe 280-X / 281-X / 282-X
Type 280-X / 281-X / 282-X

Baureihe type	DN [mm]	Druck pressure range [bar]	Anschluss connection	K _v -Wert flow rate [m ³ /h]	Gewicht - Messing weight - brass [kg]
280-X	10	0 - 64	G1/4, G3/8, G1/2	2,7	1,5
280-X	15	0 - 64	G3/8, G1/2, G3/4	7,2	3,2
280-X	20	0 - 64	G1/2, G3/4, G1	9,4	4,0
280-X	25	0 - 64	G3/4, G1, G1 1/4	14,5	5,3
280-X	32	0 - 64	G1, G1 1/4, G1 1/2	20,0	6,9
280-X	40	0 - 64	G1 1/2	45,7	11,7
280-X	50	0 - 64	G2	47,2	11,7
281-X	10	0 - 120	G1/4, G3/8, G1/2	2,7	1,5
281-X	15	0 - 120	G3/8, G1/2, G3/4	7,2	3,2
281-X	20	0 - 120	G1/2, G3/4, G1	9,4	4,0
281-X	25	0 - 120	G3/4, G1, G1 1/4	14,5	5,3
281-X	32	0 - 100	G1, G1 1/4, G1 1/2	20,0	6,9
281-X	40	0 - 100	G1 1/2	45,7	11,7
281-X	50	0 - 100	G2	47,2	11,7
282-X	10	0 - 160	G1/4, G3/8, G1/2	2,7	1,5
282-X	15	0 - 160	G3/8, G1/2, G3/4	7,2	3,2
282-X	20	0 - 160	G1/2, G3/4, G1	9,4	4,0
282-X	25	0 - 160	G3/4, G1, G1 1/4	14,5	5,3

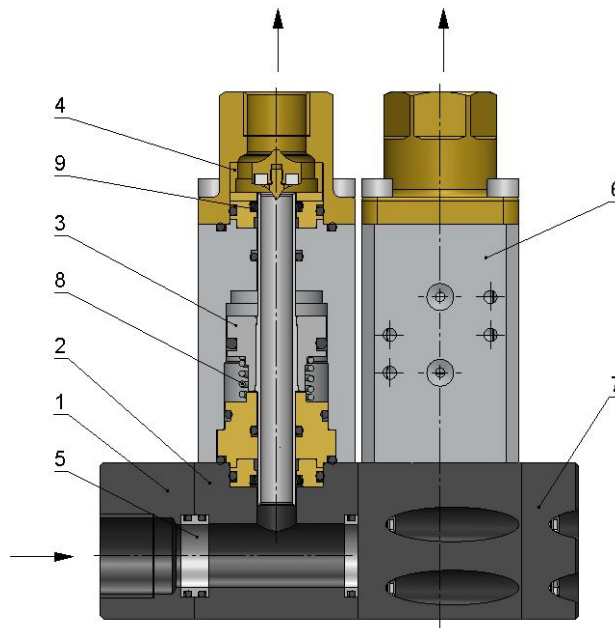
Schnittzeichnung
sectional drawing

Pos. pos.	Menge quantity	Benennung	description
1	1	Anschlusstück links	fitting left
2	2	Blockmodul	block module
3	2	Kolben	piston
4	2	Ventilsitz	valve seat
5	3	Distanzstück	distance piece
6	2	Zylinder	cylinder
7	1	Abschlussdeckel	end cover
8	1	Feder	spring
9	2	PTFE-Stangendichtung	PTFE-rod seal

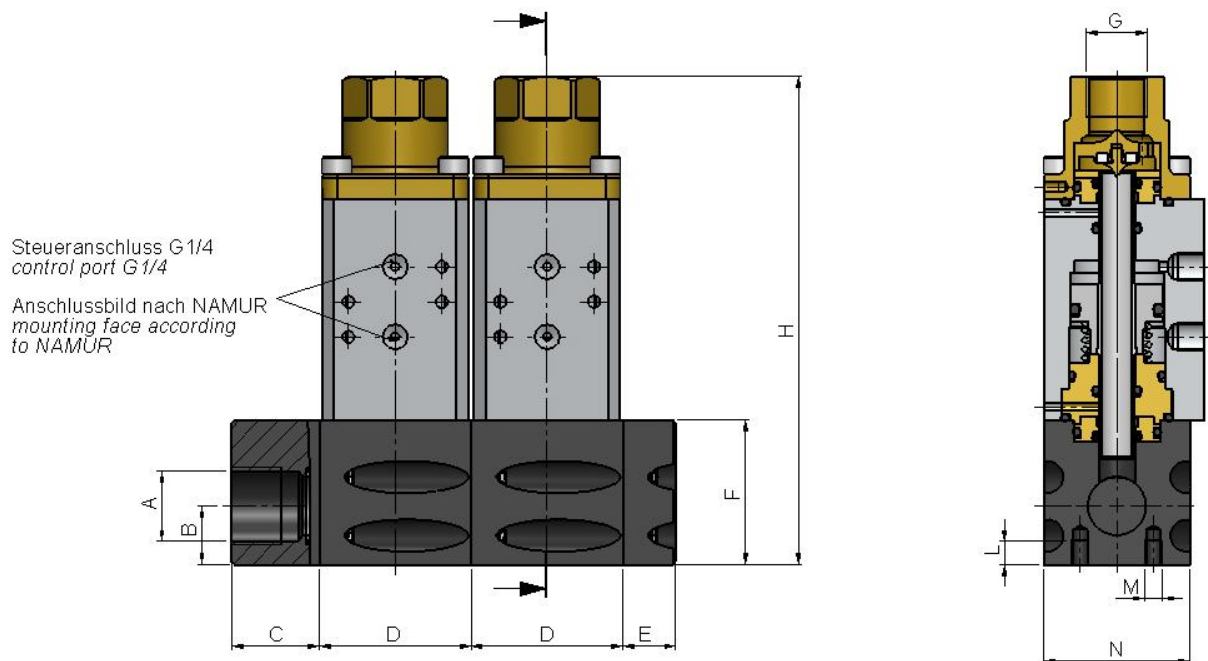
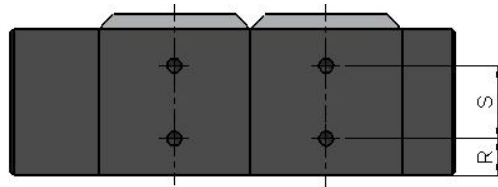
2/2-Wege Coaxialventil
2/2-way coaxial valve
Baureihe 280-X / 281-X / 282-X
Type 280-X / 281-X / 282-X
Maßzeichnung
dimension drawing

DN [mm]	A	B [mm]	C [mm]	D [mm]	E [mm]	F [mm]	H [mm]	G	L [mm]	M [mm]	N [mm]	R [mm]	S [mm]
10	G1/2, G3/4, G1	20	42	52	18	49,5	167	1/4, 3/8, 1/2	8	M6	50	13	25
15	G1/2, G3/4, G1, G1 1/4	28	42	72	27	69,5	207	3/8, 1/2, 3/4	8	M6	70	21	28
20	G1, G1 1/4, G1 1/2	34	32	82	32	79,5	235	1/2, 3/4, 1	10	M8	80	25	34
25	G1, G1 1/4, G1 1/2	36	32	92	32	89,5	265	3/4, 1, 1 1/4	10	M8	90	20	50
32	G1 1/4, G1 1/2, G2	44	34	93	34	99,5	287	1, 1 1/4, 1 1/2	10	M8	90	21	50
40	G1 1/2, G2, G2 1/2	58	40	132	40	129,5	339	1 1/2	21	M12	130	30	70
50	G1 1/2, G2, G2 1/2	58	40	132	40	129,5	339	2	21	M12	130	30	70

2/2-Wege Coaxialventil 2/2-way coaxial valve



Baureihe 280-X / 281-X / 282-X Type 280-X / 281-X / 282-X

Typenschlüssel type code

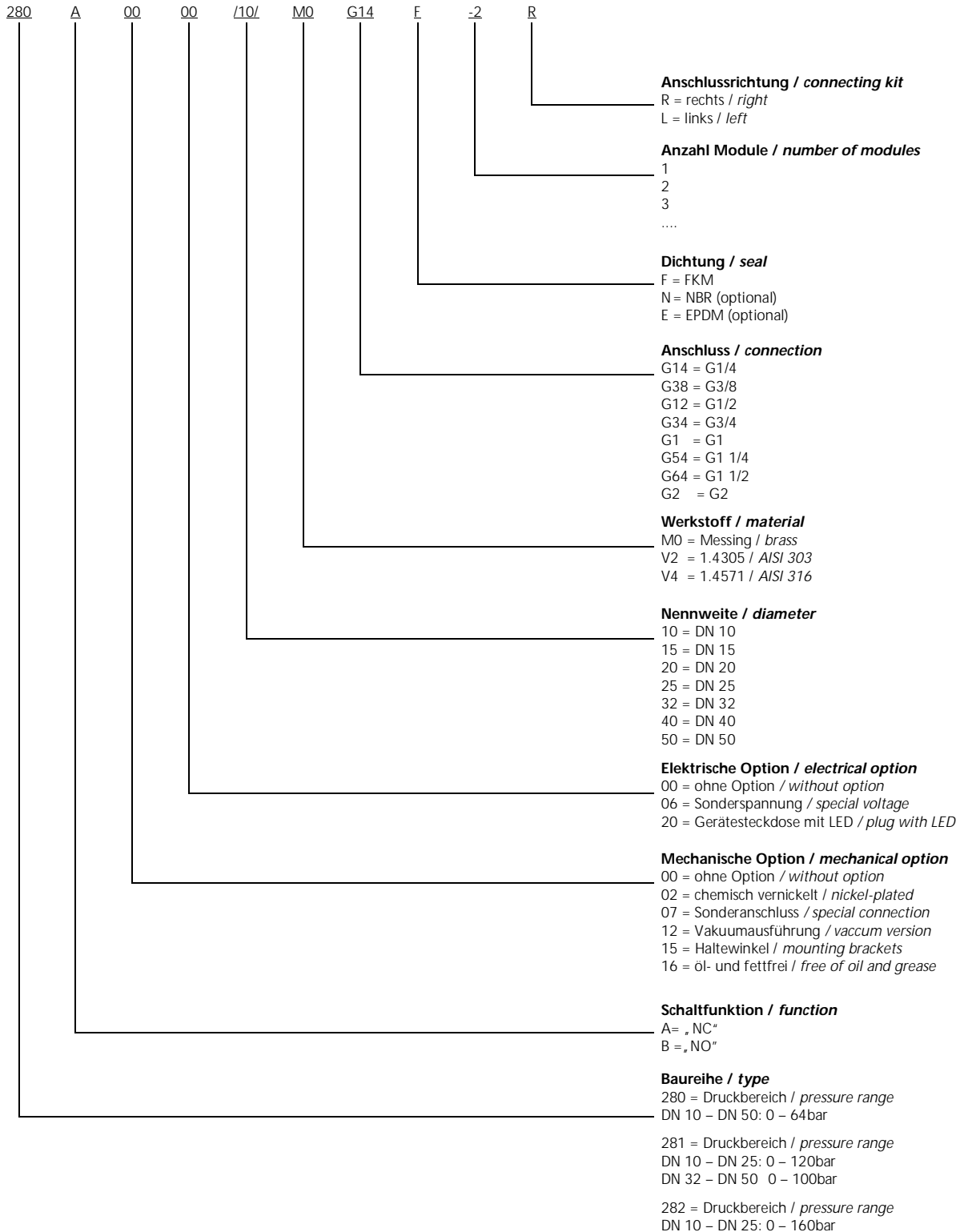
Die Typenbezeichnung setzt sich zusammen aus:
structure of the order specification:

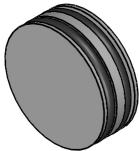
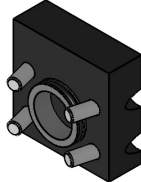

2/2-Wege Coaxialventil
2/2-way coaxial valve
Baureihe 280-X / 281-X / 282-X
Type 280-X / 281-X / 282-X
Zubehör
accessories

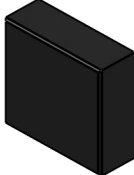
Verbindungsstücke <i>connecting pieces</i>		Abschlussstücke <i>end covers</i>	
	Trennscheibe <i>isolation disc</i>		Abschlussstück rechts <i>end cover right</i>
	Distanzstück <i>distance piece</i>		Abschlussstück links <i>end cover left</i>

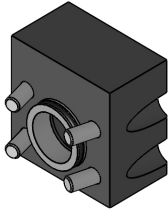
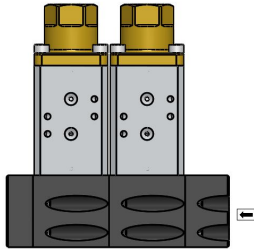
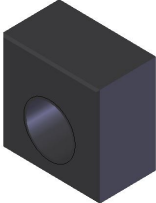
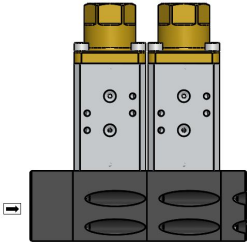

Anschlussstücke <i>connection parts</i>		
	Anschlussstück rechts <i>connection part right</i>	
	Anschlussstück links <i>connection part left</i>	

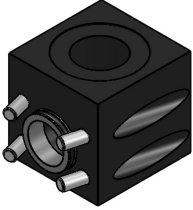
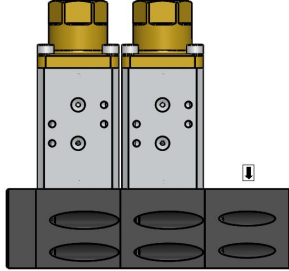
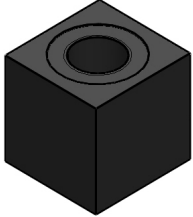
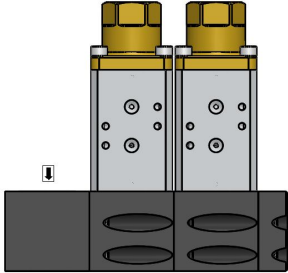
2/2-Wege Coaxialventil
2/2-way coaxial valve
Baureihe 280-X / 281-X / 282-X
Type 280-X / 281-X / 282-X

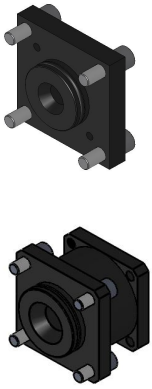
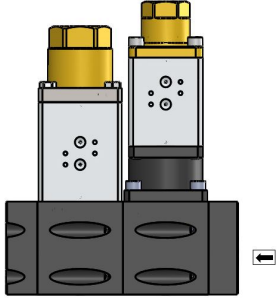

	<p>Anschlussstück rechts Eckausführung G1 nach oben <i>connection part right 90° G1</i></p>	
	<p>Anschlussstück links Eckausführung G1 nach oben <i>connection part left 90° G1</i></p>	

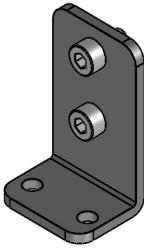
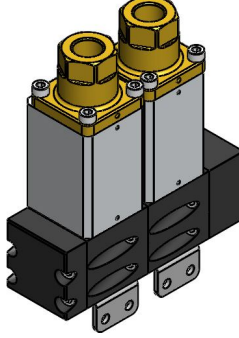
<p>Reduzieradapter <i>reducing adapters</i></p>		
	<p>Reduzieradapter <i>reducing adapter from</i></p> <p>DN 15 auf / to DN 10 DN 25 auf / to DN 10 DN 25 auf / to DN 15 DN 32 auf / to DN 20</p>	

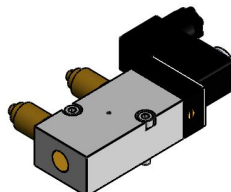
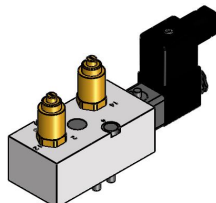
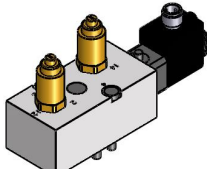
2/2-Wege Coaxialventil
2/2-way coaxial valve
Baureihe 280-X / 281-X / 282-X
Type 280-X / 281-X / 282-X

Weitere Optionen <i>further options</i>		
	Haltewinkel <i>mounting brackets</i> mechanische Option = 15 <i>mechanical option = 15</i>	
	Abluftdrossel <i>exhaust air throttle</i> G1/8 G1/4	
	Schalldämpfer Sinterbronze <i>silencer of sinter bronze casting</i> G1/8 G1/4	
	5/2-Wege Pilotventil (NAMUR) zum Anflanschen Anschlüsse seitlich <i>5/2-way pilot valve (NAMUR) to flange connections laterally</i> 24V DC 230V 50Hz	
	5/2-Wege Pilotventil (NAMUR) zum Anflanschen Anschlüsse oben <i>5/2-way pilot valve (NAMUR) to flange connections above</i> 24V DC 230V 50Hz	
	5/2-Wege Pilotventil (NAMUR) zum Anflanschen Anschlüsse oben Magnet M12x1 <i>5/2-way pilot valve (NAMUR) to flange connections above solenoid M12 x 1</i> 24V DC 230V 50Hz	

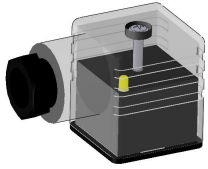
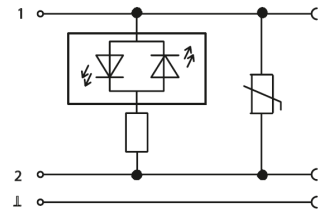
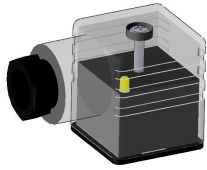
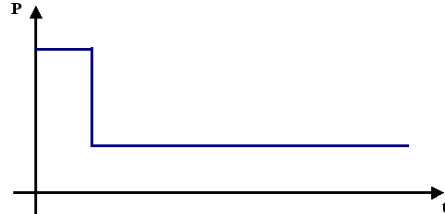
2/2-Wege Coaxialventil
2/2-way coaxial valve
Baureihe 280-X / 281-X / 282-X
Type 280-X / 281-X / 282-X

	<p>Gerätesteckdose mit LED <i>plug with LED</i></p> <p>elektrische Option = 20 <i>electrical option = 20</i></p>	
	<p>Gerätesteckdose mit Leistungsabsenkung 24V DC Bauform A <i>plug with power reduction form A</i></p> <p>elektrische Option = 07 <i>electrical option = 07</i></p>	
	<p>Sonderschutzart <i>explosion proof</i></p> <p>II 2G Ex m II T4 II 3D IP65 T130°C</p> <p>elektrische Option = 13 <i>electrical option = 13</i></p>	<p>der Betriebsdruck ist bei Ex-Ausführung um ca. 20% reduziert <i>operating pressure is reduced by 20% in Ex specification</i></p>

Weitere Optionen und Zubehör stimmen wir gerne auf Ihre Anforderungen ab.
We gladly coordinate further options and accessories according to your requirements.